

INFORMATION TABLE

Profile type	Visible element [mm]	Joint width [mm]	Base width [mm]	Installation height [mm]	Material type	Maximum load [kN]	Horizontal/Vertical compensation [mm]
EL 65.10.20	65	65	185	20	Aluminum, modified PVC	30	20(±10) 20(±10)

CONECTO EL 65.10.20
VIEW

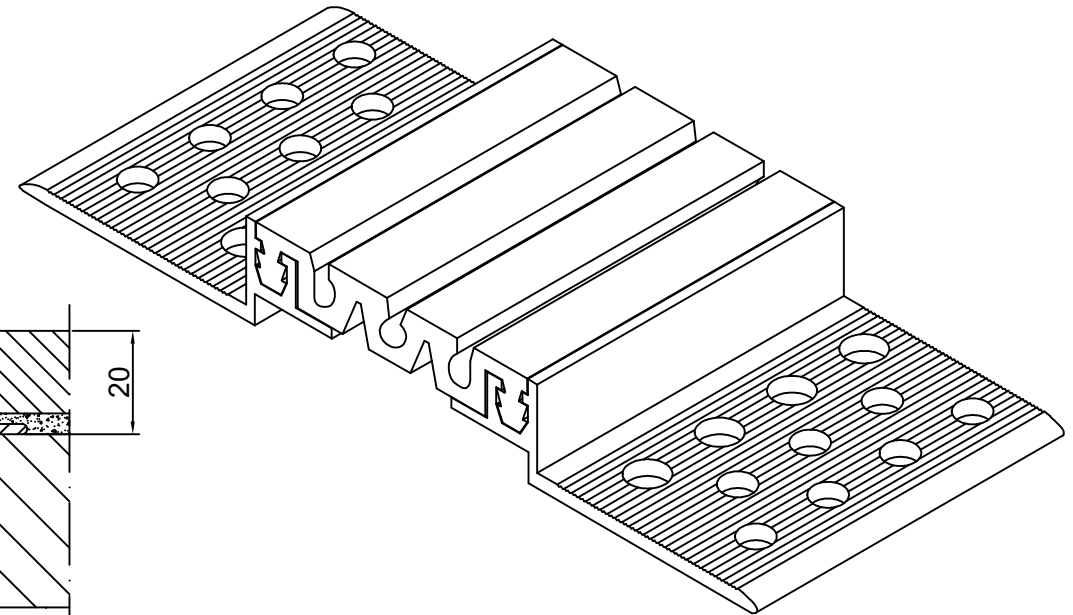

CONECTO EL 65.10.20
SECTION

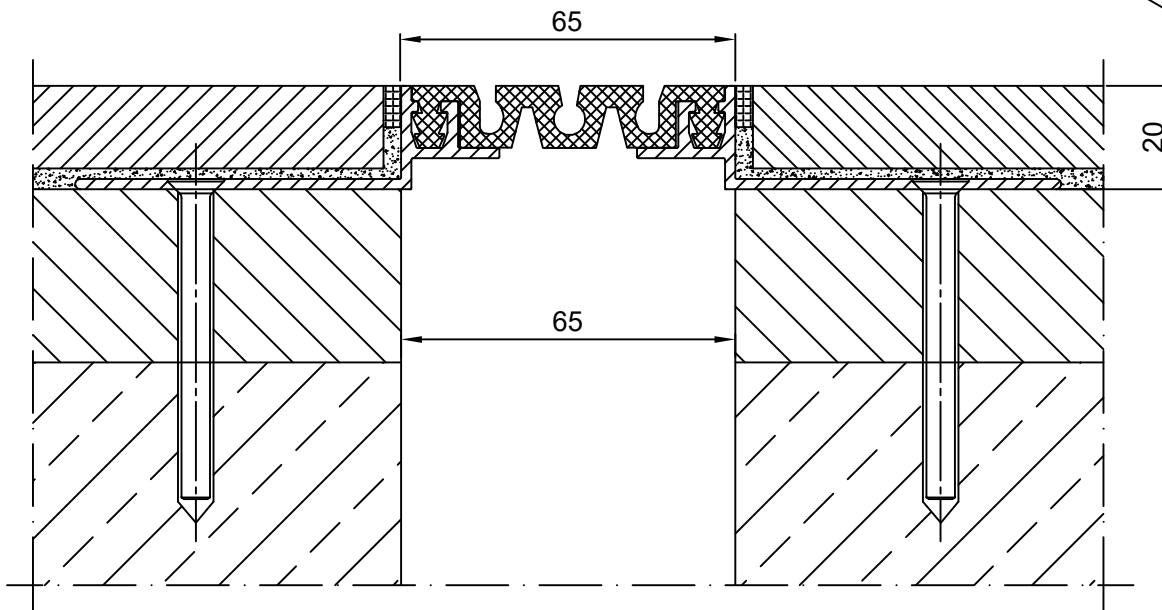

Expansion joint Conecto Elasto
65.10.20

Conecto Profiles Sp. z o.o.
ul. Przemysłowa 39
61-541 Poznań
www.conecto-profiles.com



ROZMIAR / SIZE A3	SKALA / SCALE 1:1	Wszystkie wymiary podano w [mm] All dimensions in [mm]
----------------------	----------------------	---

PROJEKT	PROJECT	ZŁOŻENIE	SUB ASSEMBLY	RYSUNEK	DRAWING	ARKUSZ	SHEET	WER	REV
--		--		01		1	Z OF	1	